

Contents

INTRODUCTION

Welcome to CORNERED speakers

GETTING STARTED

1. Find the perfect spot
2. Mount the speakers
3. Connect the cables

DAILY USE OF YOUR SPEAKERS

A powerful experience

Cleaning and maintenance

Disposing of electrical appliances

NOTES FOR THE PROFESSIONAL INSTALLER

SPECIFICATIONS

Warranty & service

DECLARATION OF CONFORMITY

Congratulations!

You are up for a great looking and great sounding experience

With the purchase of your CORNERED speakers, you can enjoy two things in one: Unique design and excellent sound.

CORNERED speakers feature a one-of-a-kind 90-degree triangular design that makes for a discreet and elegant installation anywhere in your home - in corners, on the wall, below the ceiling, on shelves and as a center and rear channel for surround sound.

But good looks aren't everything. CORNERED speakers also offers excellent sound quality. In fact, CORNERED speakers reproduce a natural three-dimensional sound stage that fills your room with sound - and strives at making listening to music one of your favorite activities.

To get the most out of your CORNERED speakers - and make the installation process as easy as possible - please take a minute to study this manual.

Enjoy!



Hans V. Madsen / Founder

Getting started

Follow 3 easy steps to install your new CORNERED speakers, and soon you'll be cornered by sound in a class of its own:

1. Find the perfect spot
2. Mount the speakers
3. Connect the cables

1. Find the perfect spot

Designed for versatile positioning

You've probably already found the perfect place for your new CORNERED speakers! The speakers will fit vertically in a corner, horizontally between the wall and the ceiling, above or below your TV as a center channel and of course behind your couch as rear channels. If you don't feel like mounting the speakers to the wall, you also have the option of placing them like traditional speakers on a shelf or on top of a piece of furniture.

Create a natural 3D sound stage

CORNERED speakers have a very wide dispersion of sound. To get the most out of the speakers, we recommend as a rule of thumb that you place them with a distance of minimum 2 meters and maximum 5 meters between the left and right speakers. Avoid placing objects such as furniture between the speakers and the listening position, as this will have a negative influence on the tonal balance of the sound. If you take these few precautions, your new speakers will reproduce a natural 3-dimensional sound stage - and give you a clear picture of each of the musicians and their position on the stage.

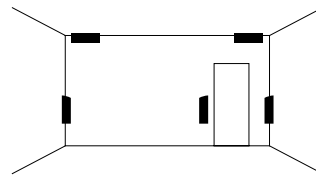

Application examples Stereo

Vertical in corner
Vertical on wall
Horizontal in corner

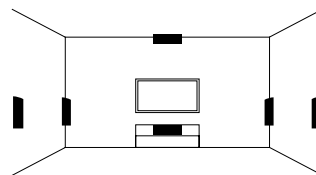

Application examples Surround

Vertical in corner as front channels
Vertical on wall as rear channels
Horizontal below TV
*Horizontal above TV

*If you wish to have the voice coming exactly from the TV screen, you have the possibility of using two centre channels, one below and one above the TV screen.

2. Mount the speakers

Vertical installation

If you prefer to mount the speaker vertically in a corner, you should:

- Remove the front cover (you'll see the mounting holes in the left and right side of the cabinet) ①
- Place speakers in desired position
- Mark drilling positions on the wall by shading through the 4 mounting holes
- Drill holes in the wall and use 5 mm rawlplugs and 4 mm screws
- Reposition the speakers in desired position and mount the screws ②
- Reinstall the front cover ③

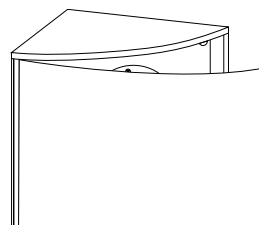

① Remove the front cover

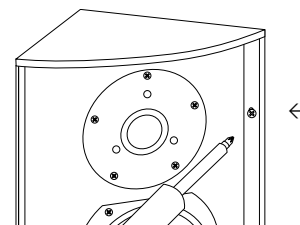

② Mounting the screws

Mounting in corners that are not exactly 90 degrees

Even if the corners in your home are not exactly 90 degrees, you can still mount your new CORNERED speakers in the corner.

- If the corner is less than 90 degrees, simply place the speaker cabinet as deep in the corner as possible and use all four mounting points. This will leave a little space behind the cabinet and the walls, but the speakers will still appear with a nice finish in the corner
- If the corner is more than 90 degrees, we recommend mounting only one of the sides of the speaker cabinet onto the wall - and leave some air behind the rear of the cabinet. This will not be visible from the front, and the speakers will still present themselves with a nice finish in the corner

Horizontal installation

If you wish to place the speakers horizontally away from the ceiling, you'll need to mount them onto a small. Here's how you do it:

- Remove the front cover
- Place speakers in desired position
- Mark drilling positions on the wall using only the two lower mounting holes
- Drill holes in the wall
- Insert the bracket in the upper mounting holes and mount the bracket to the wall
- Reinstall the front cover

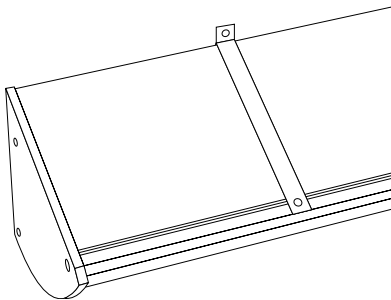

Mounting the bracket

3. Connect the cables

The speakers are equipped with discreet cable terminal placed at the rear or the bottom of the cabinet.

- Make sure the amplifier is turned off
- Connect the red plus (+) output from the amplifier to the red plus (+) cable terminal
- Connect the negative minus (-) output from the amplifier to the black minus (-) cable terminal

Important notes:

- For the best result, use speaker cables with a wire thickness of min. 1,5mm²
- If the red amplifier output is connected to the black speaker input (out of phase), the stereo imaging will be blurred, and the bass output will be dramatically reduced
- Make sure the terminals are screwed down tight after connecting the cables
- Always use the same type of cables for left and right speaker channels

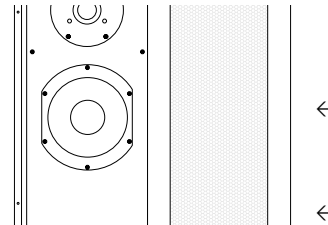

③ Reinstall the front cover

Daily use of your speakers

How to get the most out of your speakers

A powerful experience

There are many cool things about your new CORNERED speakers. Among others, they can play very loud for their size and they are very reliable.

Choosing a suitable amplifier

Here's the deal: Contrary to what many people think, a small amplifier is a greater risk to the speakers than a big one! The reason being that a small amplifier, if pressed to the limits, might become unstable and produce distortion or clipping.

This will increase the power more than 10 times to the tweeter, which may cause damage. A large amplifier however, will remain in control while playing loud. As long as the signal is clean, the speakers will have no problem receiving slightly more power than they are specified for.

Important notes:

- The tone controls should be set close to the neutral position
- If you hear distortion or mechanical sounds from the speakers, chances are that your amplifier is overdriven, and volume has to be turned down
- CORNERED speakers have a nominal impedance of 8 ohm - which makes them an easy load for the amplifier and a great match for all quality amplifiers

Cleaning and maintenance

To keep up the good looks, clean the cabinet with a soft, dry micro-fiber cloth. The front cover can be vacuumed and wiped carefully with a well-wrung, lint-free cloth with a mild all-purpose cleaner. If you need to clean the speakers behind the front cover, avoid wiping the dome tweeter as it can change the geometry of the dome and reduce the sound quality significantly.

Disposing of electrical appliances

When eventually disposing of the product, do not mix it with general household waste. There is a separate collection system for used electronic products in accordance with legislation that requires proper treatment, recovery and recycling. Private households in the EU member states, Switzerland and Norway may return their used electronic products free of charge to designated collection facilities or to a retailer (if you purchase a similar new one). For countries not mentioned above, please contact your local authorities for the correct method of disposal. By doing so, you will ensure that your disposed product undergoes the necessary treatment, recovery and recycling and thus prevent potential negative effects on the environment and human health.

Notes for the professional installer

Installation

Before installing

As CORNERED top-boxes are very light, make sure that the wall structure is solid and can support the weight of the speaker before installing the speaker. Also, make sure that you comply with all local health and safety regulations.

A one-person job

The top-boxes are extruded in aluminum and therefore more compact and lighter than a similar wooden cabinet. At the same time, the aluminum cabinet works as a large cooling surface, thus reducing power compression significantly. The low weight allows the products to be installed easily by one person. Drive units and crossover can be easily accessed behind the front cover, which can be removed without tools in a matter of seconds.

Safety wire

In installation terms, the CORNERED top-boxes are 'as much brackets as they are speakers,' so no safety wire is needed, just as you don't need a safety wire from the wall to a bracket.

Coverage

Wide dispersion even at high frequencies

CORNERED speakers are designed with emphasis on uniform and wide power response. Special emphasis is placed on phase through the crossover point and cone/dome geometry. As an example, the large surround of the tweeter dome ensures very wide dispersion also at high frequencies.

- One cabinet offers app 90x90 degree dispersion. Cabinets can be coupled together to increase coverage
- Two CORNERED cabinets can be coupled together back to back and mounted flush onto walls and ceilings while offering 180 degrees of coverage with minimum phase cancellation between the cabinets

- Three cabinets can be mounted together around a corner, offering 270 degree coverage
- And four cabinets can be mounted together and hung from the ceiling, offering 360 degree of dispersion

Recommended speaker cables

Speaker cables present the amplifier with different loads. Cables with high capacitance, high inductance and high impedance have a strong negative influence on sound quality as well as amplifier reliability. So in order to get the most out of the speaker system, avoid using thin speaker cables.

As a rule of thumb, 2 mm² (14 AWG) cable can be used for lengths up to 20 meters. 4 mm² (11 AWG) cable should be used for lengths over 20 meters. For lengths over 50 meters, some amplifiers will become unstable and sound quality and reliability will be reduced significantly.

Specifications

Front

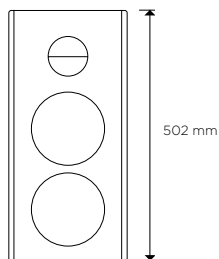

Top plate

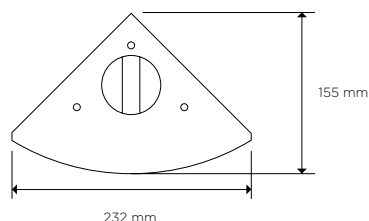

| | |
|-------------------------|---------------------------|
| Woofer: | 6 ½" |
| Tweeter: | 1" silk dome |
| Crossover: | Air coils and poly caps |
| Recommend amplifier: | 100 – 200 watt in 8 ohm |
| Sensitivity: | 90 dB |
| Max SPL long term/peak: | 111 dB/117dB |
| Frequency response: | 70-25 kHz |
| Nominal impedance: | 8 ohm |
| Dispersion: | 120x120 degree |
| Binding post: | Screw terminal or Speakon |
| Finish: | White, black, aluminium |
| Measurement: | 502mm x 232mm x 155mm |
| Weight: | 5,2 kg |

C6

C6TRM

| | |
|-------------------------|---------------------------|
| Woofer: | 6 ½" neo |
| Tweeter: | 1" horn loaded |
| Crossover: | Air coils and poly caps |
| Recommend amplifier: | 150 – 350 watt in 8 ohm |
| Sensitivity: | 91 dB |
| Max SPL long term/peak: | 115/121 dB |
| Frequency response: | 80-16 kHz |
| Nominal impedance: | 8 ohm |
| Dispersion: | 90x90 degree |
| Binding post: | Screw terminal or Speakon |
| Finish: | White, black, aluminium |
| Measurement: | 502mm x 232mm x 155mm |
| Weight: | 5,7 kg |

Warranty & service

For warranty information, please refer to your local CORNERED distributor or dealer. Spare parts for your CORNERED speakers are available through your local CORNERED distributor. In case you are not able to source spare parts locally, please contact us directly at info@cornered.dk.

Declaration of conformity

Manufacturer:

CORNERED Audio ApS
Roskildevej 16A
2620 Albertslund
Denmark

We, CORNERED Audio ApS, declare under our responsibility that the following product(s):

C6 & C6TRM
Type: Speaker

...are in conformity with:

COUNCIL DIRECTIVE of 3 May 1989 on the approximation of the laws of the Member States relating to electromagnetic compatibility (89/336/EEC)

...and has been manufactured in conformity with the following national standards that implements a harmonized standard:

EN 55013

Limits and methods of measurement of radio disturbance characteristics of broadcast receivers and associated equipment.

Hans V. Madsen / Founder

01.06.2010